

PRICE \$2.00

HEATHKIT®
ASSEMBLY MANUAL



of Statham Dec 1960

TUNNEL DIPPER











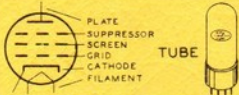

MODEL HM-10A

HEATH COMPANY
BENTON HARBOR, MICHIGAN

TYPICAL COMPONENT TYPES

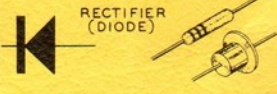
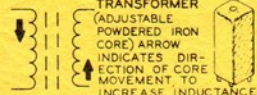
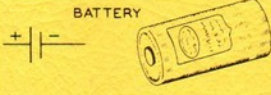
This chart is a guide to commonly used types of electronic components. The symbols and related illustrations

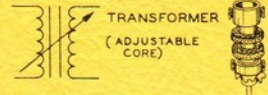
should prove helpful in identifying most parts and reading the schematic diagrams.

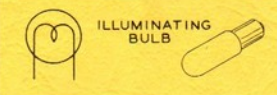
<p style="text-align: center;">RESISTOR</p> 	<p style="text-align: center;">CAPACITOR</p> 	<p style="text-align: center;">TUBE</p> 
<p style="text-align: center;">POTENTIOMETER (CONTROL)</p> 	<p style="text-align: center;">ELECTROLYTIC CAPACITOR</p> 	<p style="text-align: center;">TRANSISTOR</p> 
<p style="text-align: center;">TRANSFORMER (IRON CORE)</p> 	<p style="text-align: center;">VARIABLE CAPACITOR</p> 	<p style="text-align: center;">RECTIFIER (DIODE)</p> 
<p style="text-align: center;">TRANSFORMER (ADJUSTABLE POWDERED IRON CORE) ARROW INDICATES DIRECTION OF CORE MOVEMENT TO INCREASE INDUCTANCE</p> 	<p style="text-align: center;">BATTERY</p> 	<p style="text-align: center;">NEON BULB</p> 
<p style="text-align: center;">TRANSFORMER (ADJUSTABLE CORE)</p> 	<p style="text-align: center;">PHONO JACK</p> 	<p style="text-align: center;">ILLUMINATING BULB</p> 

Continued on Back Cover

Assembly
and
Operation
of the



TUNNEL
DIPPER

MODEL HM-10A

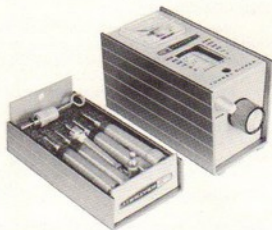

HEATH COMPANY
BENTON HARBOR,
MICHIGAN

The Heath Company reserves the right to discontinue instruments and to change specifications at any time without incurring any obligation to incorporate new features in instruments previously sold.

TABLE OF CONTENTS

Specifications2
Introduction3
Circuit Description3
Construction Notes5
Parts List6
Proper Soldering Techniques11
Schematic13*
Circuit Board Wiring And Soldering13
Step-By-Step Procedure14
Step-By-Step Assembly15
Circuit Board Assembly15
Chassis Assembly20
Front Panel Assembly And Final Wiring22
Initial Operation Check25
Applications And Operation27
In Case Of Difficulty28
Troubleshooting Chart29
Service Information30
Warranty33
Replacement Parts Price List35

*Fold-out from page.

SPECIFICATIONS

Frequency Range.	3 to 260 mc (using the six coils supplied).
Controls.	Frequency. Switch (OFF-DIODE-OSC). SENS (Sensitivity).
Circuitry.	Solid state. 1 - Tunnel diode (STD 633), oscillator. 1 - Crystal diode, rectifier. 1 - Silicon diode, voltage stabilizer. 1 - 2N407 transistor, DC amplifier. 2 - TI363 transistor, DC amplifier.
Meter.	D'arsonval type, 0-1 ma full scale.
Power Requirements.	1.5 volts at 5 ma.
Power Supply.	AA penlite cell (not furnished).
Dimensions.	5-7/8" long x 2-13/16" wide x 4-3/16" high (cover inclu
Net Weight.	1-1/2 lbs.

INTRODUCTION

Your Heathkit Tunnel Dipper features a solid-state circuit that uses three transistors, a crystal diode, and a "tunnel diode." The use of a tunnel diode, which is basically a negative-resistance device, is unique in test equipment design.

Primarily, the Tunnel Dipper functions as a grid dip meter to determine the resonant frequency of a tuned circuit. Other functions include its use as a sensitive wavemeter for checking

harmonics and parasitics. As a variable frequency signal source it can be used for receiver testing.

Any of the six frequency ranges can be selected by using the appropriate plug-in coil; for your convenience, the six plug-in coils are stored in the cabinet top. Its compact size and penlite battery-powered circuit make the Tunnel Dipper completely portable. A circuit board is used in the kit for ease of assembly.

CIRCUIT DESCRIPTION

Refer to the Schematic Diagram (fold-out from Page 13) when reading the following description.

The Tunnel Dipper uses a tunnel diode as an oscillator, a crystal diode as a rectifier, and three transistors in a meter amplifier circuit. A single 1.5 volt penlite battery is used as the power source.

TUNNEL DIODE THEORY

The tunnel diode is a semiconductor device, similar to a crystal diode in construction, that exhibits negative resistance characteristics. This makes it usable as either an amplifier or oscillator.

Most materials have positive electrical resistance properties.

This means that as a voltage applied to the material is increased, the current through the material increases; as the applied voltage decreases the current also decreases.

The negative resistance device operates in just the opposite way: When the applied voltage increases, the current through the device decreases; when the applied voltage decreases, the current through the device increases. The tunnel diode exhibits this property only over a small range of applied voltages.

OSCILLATOR CIRCUIT

The upper section of the switch connects the tunnel diode in the circuit only in the OSCillator position; this protects the tunnel diode from RF overloading, and avoids lowering the

impedance of the tuned circuit in wavemeter (DIODE position) applications.

The oscillator circuit consists of the tank circuit and the tunnel diode. The tank circuit uses a variable capacitor (C2A, or both C2A and C2B) in parallel with the plug-in coil, for tuning a wide range of frequencies.

Capacitor C2B is connected in parallel with C2A by longer pins on each of the coil plugs for the four lower frequency ranges. These longer pins make contact with a spring contact on the circuit board. The capacity of C2B is added to the tank circuit on these ranges to keep the proper LC ratio necessary for sine wave oscillation over the entire frequency range.

When the DC battery voltage is first applied to the tank circuit through the tunnel diode, a damped oscillation starts to take place. The negative resistance effect allows current to flow through the tunnel diode to the tank circuit in pulses. The amplitude of these pulses is sufficient to overcome circuit losses and supply a small pulse of current to the tank circuit during each cycle of oscillation. This small pulse of current causes the oscillation to be maintained at the same level as long as the DC voltage is applied.

Another way of explaining this oscillation would be to say that when the voltage across the tank circuit is at maximum, the voltage across the tunnel diode is at minimum, resulting in a large current flow to the tank circuit from the battery. When the voltage across the tank circuit becomes minimum, the

voltage across the tunnel diode becomes maximum, and only a small amount of current flows into the tank circuit. Thus, the current in the tank circuit is replenished by current from the battery during each cycle of oscillation.

When a tuned circuit is placed near the plug-in coil, energy will be absorbed from the tank circuit of the Tunnel Dipper by inductive coupling. This absorption, which is maximum at the resonant frequency of the tuned circuit, causes the RF voltage in the Tunnel Dipper tank circuit to decrease. This voltage decrease reduces the rectified voltage fed through the amplifier, causing a "dip" in the meter reading when the Tunnel Dipper is tuned through the resonant frequency of the unknown tuned circuit.

AMPLIFIER AND METER CIRCUITS

The voltage developed across the tuned circuit is rectified by diode D2, amplified by the DC amplifier, and then measured by the meter.

A small amount of current from the tank circuit is coupled through capacitor C1, rectified by diode D2, and applied to the base of transistor Q1. Rectifier diode D2 is connected from the base circuit to the emitter of transistor Q1.

Transistor Q1 acts as an emitter follower; the rectified voltage at its base is coupled by its emitter to the base of transistor Q2. Transistors Q2 and Q3 form a direct-coupled high-gain amplifier. Small voltage changes at the base of Q2

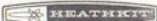

result in large current changes at the collector of Q3. The collector current of transistor Q3 is measured by the meter. SENSitivity control R4 provides proper bias for the base of transistor Q1 to keep the meter readings on scale.

Resistor R9, which is connected between the base and emitter of transistor Q2, stabilizes the load on transistor Q1. Silicon diode D3 is connected in the emitter circuit of transistor Q3 to provide a constant voltage source for transistor Q2. Resistor R5 maintains a minimum current through diode D3.

Resistors R7 and R8 form a voltage divider that provides a low impedance source of low voltage for the tunnel diode. The tunnel diode operates at approximately 100 millivolts.

CONSTRUCTION NOTES

This manual is supplied to assist you in every way to complete your kit with the least possible chance for error. The arrangement shown is the result of extensive experimentation and trial. If followed carefully, the result will be a stable instrument, operating at a high degree of dependability. We suggest that you retain the manual in your files for future reference, both in the use of the instrument and for its maintenance.

UNPACK THE KIT CAREFULLY AND CHECK EACH PART AGAINST THE PARTS LIST. In so doing, you will become

The lower section of the switch turns on the battery voltage in both the DIODE and OSCillator positions. The upper section of the switch connects the tunnel diode into the circuit only in the OSCillator position.

WAVEMETER OPERATION

When the switch is placed in the DIODE position, the Tunnel Dipper can be used as a wavemeter. The meter circuit indicates that radio frequency energy is being picked up from some external source by the tank circuit. The tunnel diode is disconnected from the circuit because its low circuit impedance would give the tuned tank circuit a very low Q and practically no response as a wavemeter.

acquainted with the parts. Refer to the charts and other information on the inside covers of the manual to help you identify the components. If some shortage or parts damage is found in checking the Parts List, please read the Replacement section and supply the information called for therein.

Resistors generally have a tolerance rating of 10% unless otherwise stated in the Parts List.

We suggest that you do the following before work is started:

1. Lay out all parts so that they are readily available.
2. Provide yourself with good quality tools. Basic tool requirements consist of a screwdriver with a 1/4" blade; a small screwdriver with a 1/8" blade; long-nose pliers; wire cutters, preferably separate diagonal cutters; a tool for stripping insulation from wires; a soldering iron (or gun) and rosin core solder. A set of nut drivers and a nut starter, while not necessary, will aid in construction of the kit.

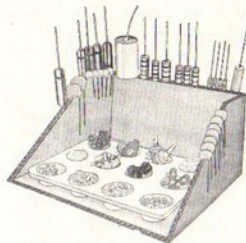

Most kit builders find it helpful to separate the various parts into convenient categories. Muffin tins or molded egg cartons make convenient trays for small parts. Resistors and capacitors may be placed with their lead ends inserted in the edge of a piece of corrugated cardboard until they are needed. Values can be written on the cardboard next to each component. The illustration shows one method that may be used.

PARTS LIST

The numbers in parentheses in the Parts List are keyed to the numbers on the Parts drawings to aid in parts identification.

PART No.	PARTS Per Kit	DESCRIPTION
<u>Resistors</u>		
(1) 1-1	1 ✓	47 Ω 1/2 watt (yellow-violet-black)
1-119	2 ✓	560 Ω 1/2 watt (green-blue-brown)
1-9	1 ✓	1000 Ω 1/2 watt (brown-black-red)

PART No.	PARTS Per Kit	DESCRIPTION
<u>Resistors (Cont'd.)</u>		
1-19	2 ✓	6800 Ω 1/2 watt (blue-gray-red)
1-26	2 ✓	100 KΩ 1/2 watt (brown-black-yellow)

(1)



PART No.	PARTS Per Kit	DESCRIPTION
----------	---------------	-------------

Capacitors-Control-Switch

21-33	1 ✓	3.3 μ f disc capacitor
21-94	2 ✓	.05 μ f disc capacitor
26-86	1 ✓	2-section variable capacitor
10-90	1 ✓	100 K Ω control
60-30	1 ✓	Slide switch

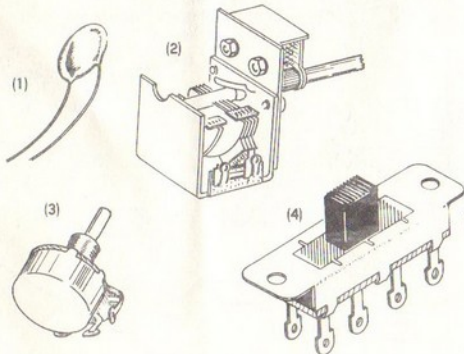

PART No.	PARTS Per Kit	DESCRIPTION
----------	---------------	-------------

Coils

(5) 40-401	1 ✓	Red band (3 to 7 mc)
40-402	1 ✓	Purple band (5 to 13 mc)
40-403	1 ✓	Blue band (12 to 32 mc)
40-404	1 ✓	Green band (30 to 90 mc)
40-405	1 ✓	Yellow band (80 to 160 mc)
40-469	1 ✓	White band (150 to 260 mc)

(5)



Hardware

(6) 250-49	2 ✓	3-48 screw
(7) 250-156	1 ✓	4-40 setscrew, allen head
(8) 250-213	4	4-40 x 5/16" screw, pan head
(9) 250-4	2 ✓	4-40 x 3/8" screw, round head
(10) 250-95	2 ✓	5-40 x 3/4" screw



(6)



(7)



(8)



(9)



(10)

PART No.	PARTS Per Kit	DESCRIPTION
----------	---------------	-------------

Hardware (cont'd.)

- | | | | |
|-----|---------|-----|------------------------------------|
| (1) | 250-70 | 4 ✓ | 6-32 x 3/16" screw, flat head |
| (2) | 250-124 | 1 ✓ | 6-32 x 3/16" screw, fillister head |
| (3) | 250-89 | 3 ✓ | 6-32 x 3/8" screw |
| (4) | 250-43 | 1 ✓ | 8-32 setscrew |

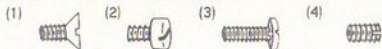

- | | | | |
|------|--------|------|--------------------|
| (5) | 252-1 | 2 ✓ | 3-48 nut |
| (6) | 252-15 | 10 ✓ | 4-40 nut |
| (7) | 252-40 | 2 ✓ | 5-40 nut |
| (8) | 252-3 | 4 ✓ | 6-32 nut |
| (9) | 252-22 | 1 ✓ | Speednut |
| (10) | 252-39 | 1 ✓ | 1/4-32 control nut |

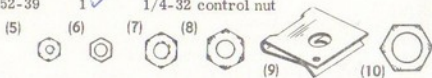

- | | | | |
|------|--------|-----|--------------------------|
| (11) | 252-7 | 2 ✓ | 3/8-32 control nut |
| (12) | 253-1 | 1 ✓ | Fiber flat washer, thin |
| (13) | 253-2 | 1 ✓ | Fiber shoulder washer |
| | 253-34 | 1 ✓ | Fiber flat washer, thick |



PART No.	PARTS Per Kit	DESCRIPTION
----------	---------------	-------------

Hardware (cont'd.)

- | | | | |
|------|--------|------|----------------------------|
| (14) | 253-10 | 2 ✓ | 5/8" OD flat steel washer |
| (15) | 253-39 | 1 ✓ | 9/16" OD flat steel washer |
| (16) | 254-7 | 2 ✓ | #3 lockwasher |
| (17) | 254-9 | 14 ✓ | #4 lockwasher |
| (18) | 254-1 | 6 ✓ | #6 lockwasher |
| (19) | 254-14 | 1 ✓ | 1/4" lockwasher |

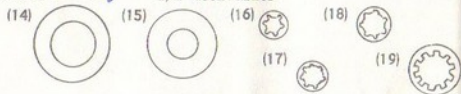

- | | | | |
|------|--------|-----|------------------|
| (20) | 254-5 | 1 ✓ | 3/8" lockwasher |
| (21) | 255-1 | 2 ✓ | 1/8" spacer |
| (22) | 255-3 | 2 ✓ | 3/8" spacer |
| (23) | 255-11 | 1 ✓ | 1" tapped spacer |
| (24) | 258-5 | 1 ✓ | Contacter spring |

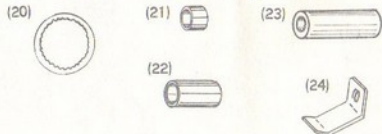

<u>PART No.</u>	<u>PARTS Per Kit</u>	<u>DESCRIPTION</u>
-----------------	----------------------	--------------------

Hardware (cont'd.)

258-31	1 ✓	Battery spring
259-6	1 ✓	Solder lug
260-11	1 ✓	Catch clip
262-4	1 ✓	Catch pin

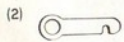

Sheet Metal Parts

90-203-1	1 ✓	Cabinet top, inside (gray)
90-202	1 ✓	Cabinet top, outside (green)

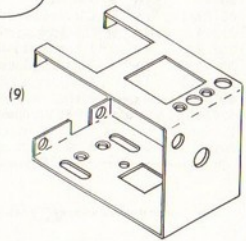
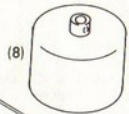
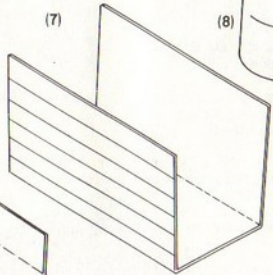
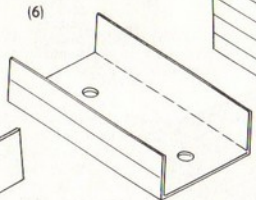
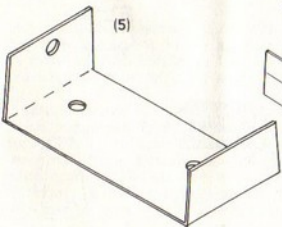

<u>PART No.</u>	<u>PARTS Per Kit</u>	<u>DESCRIPTION</u>
-----------------	----------------------	--------------------

Sheet Metal Parts (cont'd.)

(7) 90-197	1 ✓	Cabinet bottom
(8) 100-354	1 ✓	Dial drum
(9) 200-327	1 ✓	Chassis

PART No.	PARTS Per Kit	DESCRIPTION
----------	---------------	-------------

Sheet Metal Parts (cont'd.)

203-281-2

1 ✓ Front panel

(1) 204-445 1 ✓ Battery bracket

Miscellaneous

- | | | |
|------------|-----|--------------------------|
| (2) 56-26 | 1 ✓ | Crystal diode |
| 56-10 | 1 ✓ | Silicon diode (TIG247) |
| (3) 56-17 | 1 ✓ | Tunnel diode, GE STD 633 |
| 347-7 | 1 ✓ | Length 4-conductor cable |
| 85-87-1 | 1 ✓ | Circuit board |
| (4) 212-4 | 1 ✓ | Connecting strip |
| (5) 382-44 | 1 ✓ | Foam coil holder |
| 390-120 | 1 ✓ | Battery placement label |
| 390-122 | 1 ✓ | Dial drum label |
| 407-87 | 1 ✓ | Meter |
| 417-50 | 2 ✓ | TI 363 transistor |

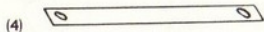

(1)

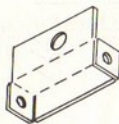

(5)

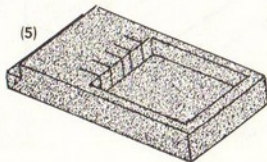

PART No.	PARTS Per Kit	DESCRIPTION
----------	---------------	-------------

Miscellaneous (cont'd.)

- | | | | |
|-------------|-----|-------------------------------------|-------|
| 417-51 | 1 ✓ | 2N185 transistor | 2N407 |
| (6) 434-42 | 1 ✓ | Phono socket | |
| (7) 434-70 | 3 ✓ | Transistor socket | |
| 446-32 | 1 ✓ | Dial window | |
| (8) 455-26 | 1 ✓ | Bushing | |
| 462-139 | 1 ✓ | Large knob | |
| (9) 462-175 | 1 ✓ | Small tapered knob | |
| 490-23 | 1 ✓ | Allen wrench | |
| 331-6 | 1 ✓ | Solder | |
| 391-34 | 1 ✓ | Blue and white identification label | |
| 597-260 | 1 ✓ | Parts order form | |
| 595-618 | 1 ✓ | Manual | |

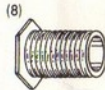
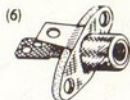

PROPER SOLDERING TECHNIQUES

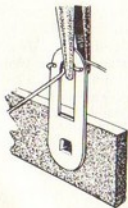

CRIMP WIRES

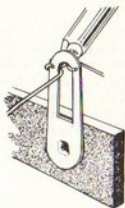

HEAT CONNECTION

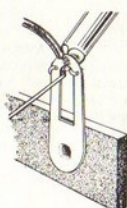

APPLY SOLDER

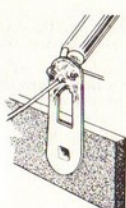
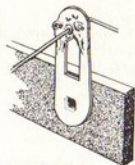
ALLOW SOLDER
TO FLOWPROPER SOLDER
CONNECTION

Only a small percentage of HEATHKIT equipment purchasers find it necessary to return an instrument for factory service. Of these instruments, by far the largest portion of malfunctions are due to poor or improper soldering.

If terminals are bright and clean and free of wax, frayed insulation and other foreign substances, no difficulty will be experienced in soldering. Correctly soldered connections are essential if the performance engineered into a kit is to be fully realized. If you are a beginner with no experience in soldering, a half hour's practice with some odd lengths of wire may be a worthwhile investment.

For most wiring, a 25 to 100 watt iron or its equivalent in a soldering gun is very satisfactory. A lower wattage iron than this may not heat the connection enough to flow the solder smoothly over the joint. Keep the iron tip clean and bright by wiping it from time to time with a cloth.

CHASSIS WIRING AND SOLDERING

1. Crimp or bend the wire around the terminal just enough to hold it in place until it is soldered. Do not knot or twist the wire around the lug.

2. Position the work, if possible, so that gravity will help to keep the solder where you want it.
3. Place a flat side of the soldering iron tip against the joint to be soldered until it is heated sufficiently to melt the solder.
4. Then place the solder against the heated terminal and it will immediately flow over the joint; use only enough solder to thoroughly wet the junction. It is usually not necessary to fill the entire hole in the terminal with solder.

5. Remove the solder and then the iron from the completed junction. Use care not to move the leads until the solder is solidified.

A poor or cold solder joint will usually look crystalline and have a grainy texture, or the solder will stand up in a blob and will not have adhered to the joint. Such joints should be reheated until the solder flows smoothly over the entire junction. In some cases, it may be necessary to add a little more solder to achieve a smooth bright appearance.

ROSIN CORE SOLDER HAS BEEN SUPPLIED WITH THIS KIT. THIS TYPE OF SOLDER MUST BE USED FOR ALL SOLDERING IN THIS KIT. ALL GUARANTEES ARE VOIDED AND WE WILL NOT REPAIR OR SERVICE EQUIPMENT IN WHICH ACID CORE SOLDER OR PASTE FLUXES HAVE BEEN USED. IF ADDITIONAL SOLDER IS NEEDED, BE SURE TO PURCHASE ROSIN CORE (60:40 or 50:50 TIN-LEAD CONTENT) RADIO TYPE SOLDER.

CIRCUIT BOARD WIRING AND SOLDERING

Before attempting any work on the circuit board, read the following instructions carefully and study the Figures. It is only necessary to observe the following basic precautions to insure proper operation of the unit the first time it is turned on.

Proper mounting of components on the board is essential. A general rule to follow is that all components on the board should be mounted tightly to the board, unless instructions state otherwise. All leads should be kept as short as possible to minimize the effects of stray capacity in the wiring. Proper and improper methods of mounting are illustrated in the accompanying Figures.

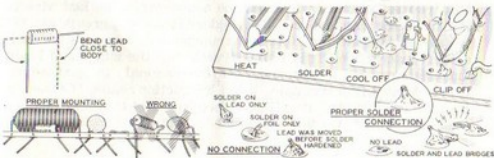

NOTE: Exercise care not to damage resistors or capacitors when bending the leads as shown. Resistors will fit properly if the leads are bent as shown. Disc capacitors will generally fit in place with no lead preparation other than determining that the leads are straight. Components with lugs normally require no

preparation unless the lugs appear to be bent, in which case they can be straightened with pliers.

Parts should be inserted as instructed, and the leads bent outward slightly, as illustrated, to lock them in place.

Components will be soldered in groups; after a group of components have been installed, instructions will be given to solder them. When the components have been soldered, diagonal cutters may be used to cut off the excess leads close to the board.

The actual technique of soldering leads to a circuit board is quite simple. Position the tip of the soldering iron so that it firmly contacts both the circuit board foil and the wire or lug to be soldered, as shown. The iron should be held so that solder is not likely to flow to adjacent foil conductors or connections. The solder should immediately be placed between the iron and the joint to be soldered. Remove the length of solder as soon as its end begins to melt onto the lead and foil. Hold the tip of the iron in place only until the solder flows outward over the foil; then remove the iron quickly.

Avoid overheating the connection. A soldering pencil or small iron (approximately 25 watts) is ideal for use in circuit board work. If only a high wattage iron or soldering gun is available, precautions must be taken to avoid circuit board damage due to overheating and excess solder.

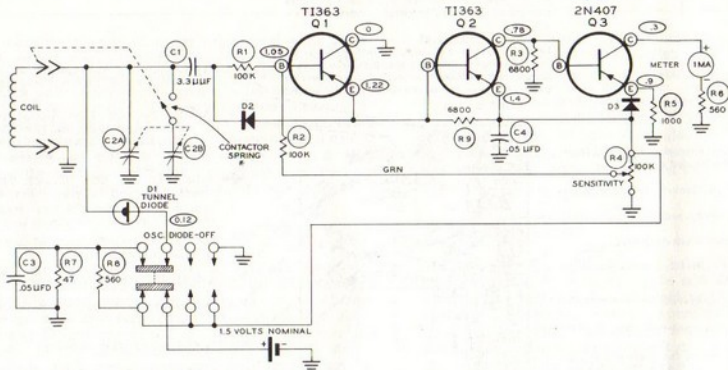

*C2B SWITCHED INTO THE CIRCUIT BY THE LONGER COIL PLUG PINS.

1. ALL RESISTOR VALUES ARE IN Ω ; K = 1000.
2. ALL RESISTORS ARE 1/2 WATT.
3. \circ INDICATES POSITIVE DC VOLTAGE MEASUREMENT FROM POINT INDICATED TO CHASSIS GROUND.
4. VOLTAGE MEASURED WITH AN 11 MEGOHM VTVM, SWITCH IN OSC POSITION AND SENS CONTROL SET TO READ 50 ON METER.

SCHEMATIC OF THE
HEATHKIT®
TUNNEL DIPPER
MODEL HM-10 A

The use of excessive amounts of solder will increase the possibility of bridging between foil conductors or plugging holes which are to be left open for wires which may be added later on. If solder is accidentally bridged across insulating areas between conductors, it can be cleaned off by heating the connection carefully and quickly wiping or brushing the solder away with a soft cloth or clean brush. Holes which become plugged can be cleared by heating the area immediately over the hole while gently pushing the lead of a resistor through the hole from the opposite side, and withdrawing the lead before the solder re-

hardens. Do not force the lead through; too much pressure before the solder has time to soften may separate the foil from the board.

In cases where foil does become damaged, repairs can usually be made with little difficulty. A break in the foil can be rejoined with a small piece of bare wire soldered across the gap, or between the foil and the lead of a component. "Hairline" breaks can usually be repaired by bridging them with a small amount of solder.

STEP-BY-STEP PROCEDURE

The following instructions are presented in a logical step-by-step sequence to enable you to complete your kit with the least possible confusion. Be sure to read each step all the way through before beginning the specified operation. Also read several steps ahead of the actual step being performed. This will familiarize you with the relationship of the subsequent operations. When the step is completed, check it off in the space provided. This is particularly important as it may prevent errors or omissions, especially if your work is interrupted. Some kit builders have also found it helpful to mark each lead in colored pencil on the Pictorial as it is added.

In general, the illustrations in this manual correspond to the actual configuration of the kit; however, in some instances the illustrations may be slightly distorted to facilitate clearly showing all of the parts.

The abbreviation "NS" indicates that a connection should not be soldered yet as other wires will be added. When the last wire is installed, the terminal should be soldered and the abbreviation "S" is used to indicate this. Note that a number will appear after each solder instruction. This number indicates the number of leads that are supposed to be connected to the terminal in point before it is soldered. For example, if the instruction reads, "Connect a lead to lug 1 (S-1)," it will be understood that there will be one lead connected to the terminal at the time it is soldered.

The steps directing the installation of resistors include color codes to help identify the parts. Also, if a part is identified by a letter-number designation on the Schematic, its designation will appear at the beginning of the construction step which directs its installation.

NOTE: Place the circuit board on your work surface as shown in Pictorial 1, with the lettered side up.

Bend the leads and install each part on the board as shown. Observe lead dimensions where shown. Next, solder the leads (or lead) and cut them off below the board flush with the solder.

1. (✓) Install the three transistor sockets on the circuit board with the holes of each socket as shown. Detail 1A shows how the leads should be bent over to touch the circuit board foils.
2. (✓) D2, Crystal diode (brown-white-brown). Note the position of the banded end.
3. (✓) R1, 100 K Ω (brown-black-yellow).
4. (✓) R9, 6800 Ω (blue-gray-red) Note lead length.
5. (✓) R2, 100 K Ω (brown-black-yellow).
6. (✓) D3, Silicon diode (#56-10), Note the position of the banded end.
7. (✓) R3, 6800 Ω (blue-gray-red).
8. (✓) R5, 1000 Ω (brown-black-red). Note lead length.
9. (✓) C1, Install the tips of the leads of the 3.3 μ f disc capacitor in the METER holes as shown. Cut off the leads as shown. This leaves two bare wires for use in later steps.

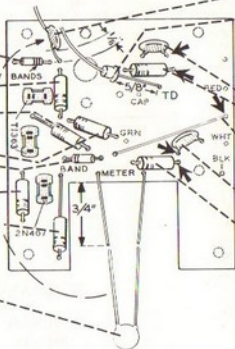

10. (✓) C1, 3.3 μ f disc capacitor. Be sure to observe the 1/8" capacitor lead dimension.
11. (✓) D1, The lead at the rimmed (larger) end of the tunnel diode, CAUTION: Do not apply excessive heat to the diode lead because it may damage the diode. Note the 5/8" diode dimension.
- ← INDICATES DO NOT SOLDER THIS LEAD. Switch lugs will be placed over these lead ends in a later step. Cut these leads off 1/8" above the foil side of the circuit board.
12. (✓) C3, .05 μ f disc capacitor. Save one of the leads to be used later.
13. (✓) R7, 47 Ω (yellow-violet-black).
14. (✓) Install one of the cut-off capacitor leads as the bare wire on the circuit board.
15. (✓) C4, .05 μ f disc capacitor.
16. () R6, 560 Ω (green-blue-brown).

Now continue with the steps on Page 15.

Pictorial 1

STEP-BY-STEP ASSEMBLY

CIRCUIT BOARD ASSEMBLY

Assemble the circuit board, using the procedure shown in Pictorial 1.

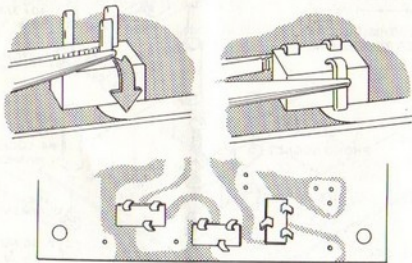

Detail 1A

Refer to Pictorial 2 (on Page 16) for the following steps.

- (✓) Use long-nose pliers to bend over each of the switch contacts as shown in Detail 2A.

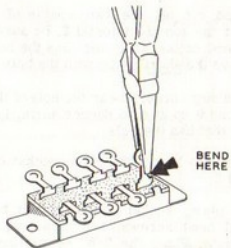

Detail 2A

- (✓) Place the switch in position on the foil side of the circuit board. The holes in the switch lugs should be centered over the holes (and the 1/8" wires) on the circuit board.
- (✓) Fasten the switch to the circuit board with 5-40 x 3/4" screws, 3/8" spacers, #4 lockwashers and 5-40 nuts. Make sure the board is not bent by the switch lugs; remove and rebend the switch lugs if necessary. Be sure that no bare wires touch the switch body.
- (✓) Measure and cut off the two lengths of connecting strip as shown at the top of Pictorial 2. Be sure the 7/8" length is at the end of the strip that has the hole closest to the edge. Discard the short piece with the hole in it.
- (✓) Cut off the sharp corners near the hole of the 7/8" length of strip and bend it up at a 90 degree angle, 1/4" from the end of the strip that has the hole.
- (✓) Bend the ground lug of the phono socket out as it is shown in Pictorial 2.
- (✓) Mount the phono socket on the circuit board with 4-40 x 3/8" round head screws, 1/8" spacers, #4 lockwashers, and 4-40 nuts. Place the 7/8" connecting strip under the lockwasher and nut nearest the center of the board. Position the connecting strip as shown, taking care that it does not touch the nearby resistor lead.
- (✓) When the phono socket is in place, the hole in its ground lug should rest on and over the end of the 47 Ω resistor lead. Solder this lug to the circuit board. Be sure that the center terminal is clear of the circuit board foil around the hole.

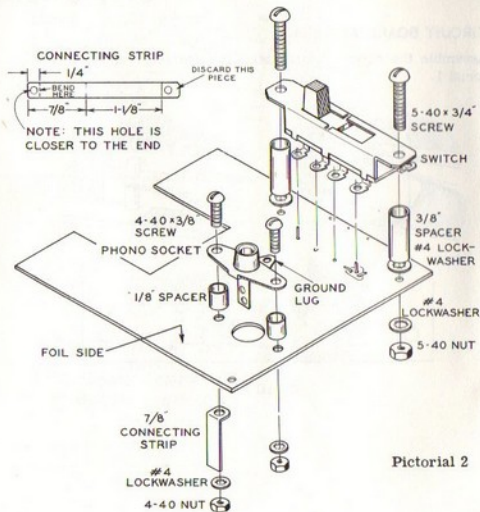

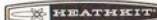

Refer to Pictorial 3 for the following steps.

- (✓) R8. Install the 560 Ω (green-blue-brown) resistor through the circuit board and switch lug holes.
- (✓) Solder all remaining resistor, jumper, and capacitor leads that were not soldered to the circuit board in Pictorial 1. Do not solder the switch lugs yet.
- (✓) Clip off all soldered leads flush with the solder. Be sure that there are no points where the solder has bridged between the foils.

- (✓) Prepare the length of 4-conductor cable as shown in Detail 3A. Strip the outer casing from each end of the cable before cutting any wire from the ends. After each wire is cut to the correct length, remove 1/4" of insulation. Save the longer black wire cut from the end of the cable.

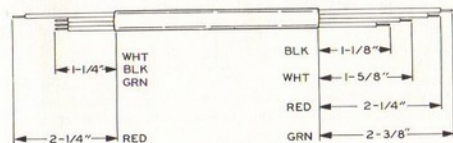
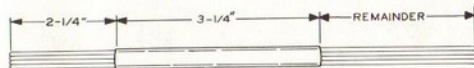

Detail 3A

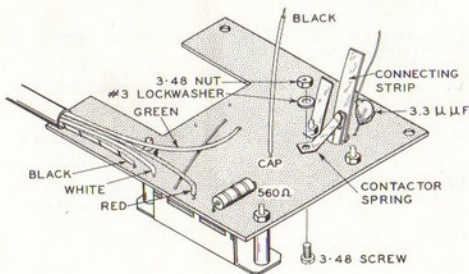

Pictorial 3

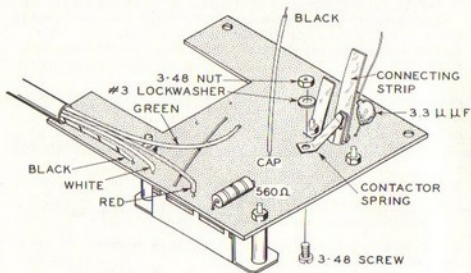

Pictorial 3

- (✓) Cut a 2-1/4" length from the black wire saved from the previous step. Remove 1/4" of insulation from each end of this wire. Insert one end of this wire through the hole marked CAP on the circuit board and solder (S-1). The other end of this wire will be connected later.

Connect the wires of the 4-conductor cable that emerge from the end of the cable having the long green wire as follows. (Be sure all strands go through the holes.) Be careful to prevent the solder from bridging to the switch body.

- (✓) Connect the black wire to the hole marked BLK on the circuit board (S-1).
- (✓) Connect the white wire to the hole marked WHT on the circuit board (S-1).
- (✓) Connect the green wire to the hole marked GRN on the circuit board (S-1).
- (✓) Connect the red wire to the hole marked RED on the circuit board (S-1).
- (✓) Turn the board over and solder any switch lugs to the circuit board that have not been soldered previously.

- (✓) Bend the contactor spring to the angles shown in Detail 3B.

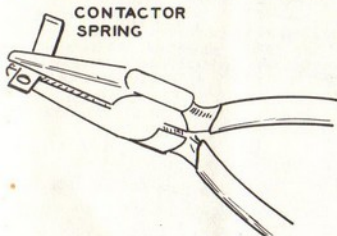

Detail 3B

ACTUAL
SIZE

- (✓) Install a 3-48 screw into the circuit board to mount the contactor spring. This screw fits tightly in the hole to provide good contact with the foil. This screw should be screwed into the hole.
- (✓) Install the contactor spring on the circuit board as shown

with a #3 lockwasher and a 3-48 nut. Tighten the screw so the tip of the spring is over the phono socket hole. Do not let the spring touch the center lug of the phono socket or the mounting hardware of the phono socket. Tighten securely.

- (✓) Plug a coil with a longer pin into the phono socket to make sure the pin makes good contact with the contactor spring. Remove the coil.
- (✓) Install the remaining 1-1/8" piece of connecting strip behind the center conductor of the phono socket. Bend the center lug of the phono socket back slightly, as it is shown in Pictorial 3 on Page 18. Solder the connecting strip to the phono lug. The end of the strip should be even with the board surface. Tin both the end of the strip and the terminal, then solder the two together.
- (✓) Place the free lead of the tunnel diode between the two connecting strips as it will be connected to one of them in a later step. Place the 3.3 μmf capacitor lead as shown in Pictorial 3.

CHASSIS ASSEMBLY

Refer to Pictorial 4 for the following steps.

- (✓) Install the speednut on the back of the chassis. Be sure the flat side of the speednut faces outward.
- (✓) Install the catch clip over the hole near the bottom of the chassis with 6-32 x 3/16" flat head screws, #6 lockwashers and 6-32 nuts.
- (✓) Install the 100 K Ω control with a 1/4" lockwasher, 9/16" flat steel washer and a 1/4-32 control nut.
- (✓) Remove the nut and lockwasher from the switch mounting screw at the edge of the circuit board. Mount the circuit board over the open end of the chassis as shown. Fasten the board by replacing the nut and lockwasher on the switch mounting screw. Do not tighten the nut now as it will be removed again later to install the front panel.
- (✓) Fasten the other three corners of the circuit board with 4-40 by 5/16" screws, #4 lockwashers, and 4-40 nuts.
- (✓) Route the single black wire out of the corner of the chassis as shown.

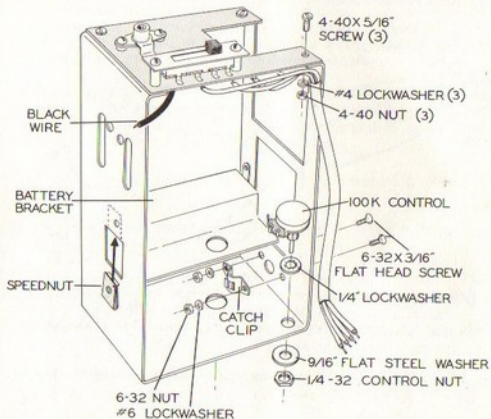

Pictorial 4

- (✓) Cut the battery label in two, and install half of it in the battery bracket as shown in Detail 4A. Discard the remainder of the label.
- (✓) Prepare the battery bracket by installing the hardware shown in Detail 4A. Position the solder lug as shown in Pictorial 4. The 3-48 (shorter) screw is used to mount the battery spring.

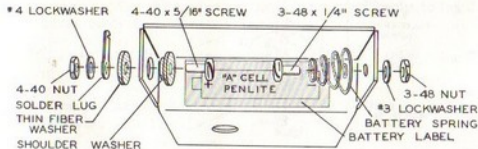

Detail 4A

- (✓) Place the battery bracket in the end of the chassis as shown in Pictorial 4. The end of the 3-48 screw should be placed in the small hole at the rear of the chassis.

Refer to Pictorial 5 for the following steps.

- (✓) Install the 8-32 setscrew in the dial drum. Refer to Detail 5A.
- (✓) Preshape the dial drum label by rolling it around a standard-size flashlight battery or some round item of similar diameter. Preshaping this label will help it stick to the dial drum in the next step.

- (✓) Remove the protective paper from the adhesive side of the dial drum label. Install the label on the dial drum as shown in Detail 5A. Note that the scale numbers are upside down when the dial drum is placed on a flat surface as shown in this detail.

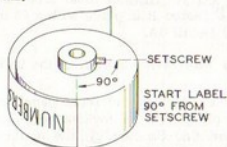

Detail 5A

NOTE: Be sure the plates of the variable capacitor are kept fully closed during the following steps.

- (✓) Install the dial drum over the shaft of the variable capacitor until the open end of the drum rests against the frame of the capacitor. Install the bushing and 3/8" lockwasher on the shaft as shown. Lubricate the bushing with vaseline or grease.
- (✓) Keep the battery bracket in its correct position. Insert the shaft of the tuning capacitor through the holes in the battery bracket and chassis as shown in part 1 of Pictorial 5. Install the bushing, with the lockwasher still in place, through the mounting holes.
- (✓) Fasten the bushing with a 5/8" flat steel washer and a 3/8-32 control nut. Fasten the tuning capacitor with the two 6-32 x 3/16" flat head screws.

FRONT PANEL ASSEMBLY AND FINAL WIRING

Refer to Pictorial 6 for the following steps.

- (✓) Install a 6-32 x 3/16" fillister head screw at the top of the front panel and fasten it in place with a #6 lockwasher and a 6-32 nut. See Detail 6A.
- (✓) Place the dial window in position on the inside of the front panel.
- (✓) Install the meter through the front panel and dial window. Fasten it in place with #4 lockwashers and 4-40 nuts as shown in Detail 6A. Be careful; the meter may be broken if nuts are over-tightened. Remove the meter shorting clip.
- (✓) Prepare to mount the front panel by removing the screws, lockwashers, and nuts used to mount the switch to the circuit board. Do not disturb the spacers and lockwashers between the switch and the circuit board. Route the two bare meter wires (on the circuit board) straight down from the circuit board.
- (✓) Install the front panel on the chassis assembly, by the following method:
 1. Insert the tuning capacitor shaft and the bushing through the larger hole in the bottom of the front panel.
 2. Insert the meter through the meter opening in the chassis and, at the same time, guide the switch openings in position over the switch.

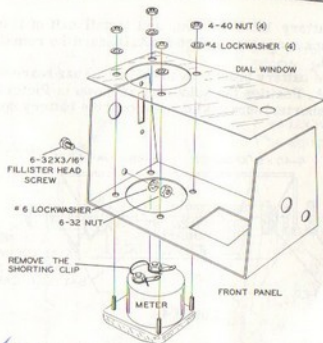

Detail 6A

- (✓) Reinstall the screws, lockwashers, and nuts that were removed from the switch.
- (✓) Install a 5/8" flat steel washer and a 3/8-32 control nut on the bushing at the bottom of the front panel.
- (✓) Install the large knob on the tuning capacitor shaft and tighten the setscrew.
- (✓) Fit the 4-40 allen head setscrew on one end of the allen wrench, and install the setscrew in the small tapered knob. Install this knob on the shaft of the control.

Refer to Pictorial 7 for the following steps.

- (✓) Place the 4-conductor cable along the edge of the chassis as shown. Connect the red wire to the solder lug on the battery bracket (S-1). See Pictorial 8 on Page 24 for this connection only.
- (✓) Connect the white wire of the 4-conductor cable to lug 3 of the control (S-1).
- (✓) Connect the green wire of the 4-conductor cable to lug 2 of the control (S-1).
- (✓) Connect the black wire of the 4-conductor cable to lug 1 of the control (S-1).
- (✓) Connect the separate black wire, coming from the circuit board to lug 4 of the tuning capacitor (S-1).
- (✓) Cut off lug 3 of the tuning capacitor, and push lug 4 close to the capacitor plates.
- (✓) Connect the closer of the two bare wires to lug 2 of the meter (S-1).

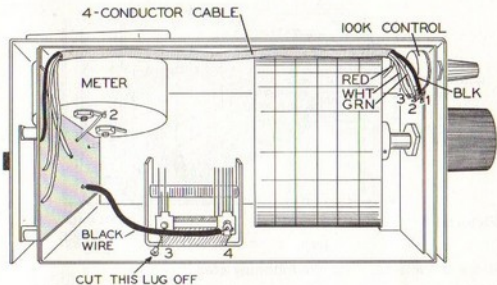

Pictorial 7

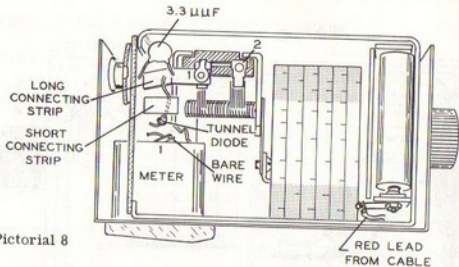

Pictorial 8

Refer to Pictorial 8 for the following steps.

NOTE: Be sure the free lead of the tunnel diode is between the two connecting strips before these strips are soldered to the tuning capacitor in the following steps.

- (✓) Fasten the long connecting strip to lug 1 of the tuning capacitor as shown in Detail 8A. First place the thick fiber washer on the tuning capacitor and place the long connecting strip on top of the fiber washer. Push lug 1 of the tuning capacitor down on top of the long connecting strip.
- (✓) Solder lug 1 of the tuning capacitor to the long connecting strip (S-1). The long connecting strip is now at the correct distance from the tuning capacitor frame; do not push it closer in any of the remaining steps.

- (✓) Solder the short connecting strip to the frame of the tuning capacitor as shown.
- (✓) Cut off lug 2 of the tuning capacitor.
- (✓) Cut the free lead of the 3.3 μ mf disc capacitor to about 3/8" and solder it to the long connecting strip (S-1).
- (✓) Place the free tunnel diode lead over the long connecting strip, making sure it does not touch the short connecting strip or the capacitor frame. Cut off the excess wire, and solder it to the long connecting strip (S-1). Remove and discard the thick fiber washer.
- (✓) Connect the remaining bare wire to lug 1 of the meter (S-1).
- (✓) Turn the tuning capacitor shaft fully counterclockwise. Now rotate the dial drum so that the line on the dial window lines up with the black line at the high frequency end of the label. Tighten the dial drum setscrew.

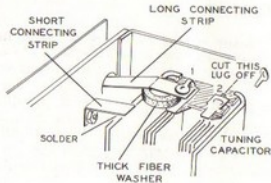

Detail 8A

- (✓) Install the transistors in the transistor sockets on the circuit board. The transistor types are lettered on the circuit board.
- (✓) Make sure the switch is in the OFF position, then install a battery in the battery bracket, according to the label polarity. Use a type AA penlite cell.
- (✓) Carefully peel away the backing paper from the blue and white identification label. Then press the label onto the rear of the cabinet (or chassis). Be sure to refer to the numbers on this label in any communications you have with the Heath Company about this kit.

This completes assembly and wiring of the chassis. Check all soldered connections and shake out any wire clippings and solder splashes.

INITIAL OPERATION CHECK

- () Turn the SENSitivity control to the full counterclockwise position. Place the switch in the DIODE position, and plug in the red coil.
- () Turn the SENSitivity control clockwise and make sure the meter can go to full scale in the DIODE position of the switch. The adjustment of the SENSitivity control is critical in that very little movement of the control can cause a large change in meter movement.
- () Adjust the SENSitivity control for a reading of 10 to 20. Move the switch to OSC, and the meter should jump upscale, indicating oscillation. Adjust the SENSitivity control for a reading between 80 and 100 for most sensitive operation.

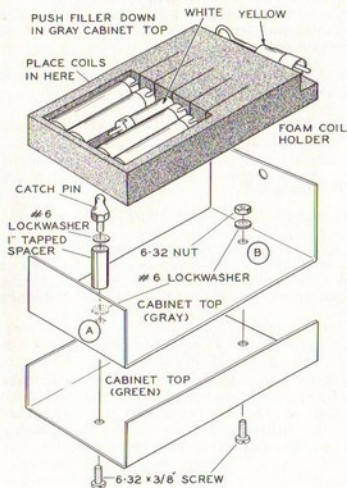

Pictorial 9

NOTE: It is normal for the meter to drift for a few minutes until the temperature of the transistors stabilizes. If any difficulty is encountered in performing the following steps, refer to the In Case Of Difficulty section of the manual.

If your Tunnel Dipper performs as described in the previous steps you may assume that it is operating properly.

- (✓) Install the cabinet bottom on the chassis with a 6-32 x 3/8" screw. See Detail 9A.

CABINET TOP ASSEMBLY

Refer to Pictorial 9 for the following steps.

- (✓) Slide the gray inner cabinet top into one end of the green top, and assemble the cabinet top as shown. Install a catch pin and its associated hardware in hole A, and install a 6-32 x 3/8" screw with #6 lockwasher and 6-32 nut in hole B.
- (✓) Press the foam coil holder into place as shown.
- (✓) All six plug-in coils may now be placed in the cabinet top for storage. Place the white marked coil in the center. The cabinet top is mounted by placing the hole located in the end, over the fillister head screw, and then pushing the catch pin into the catch clip on the front panel.
- (✓) Install the cover.

This completes the assembly of your Tunnel Dipper.

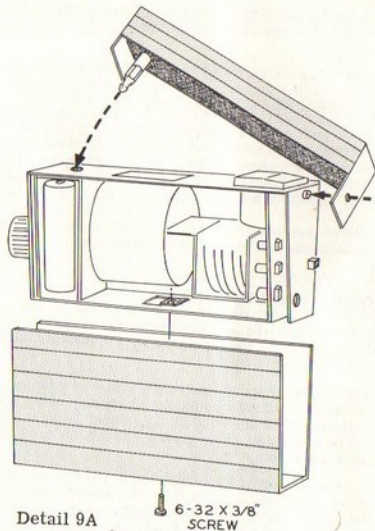

APPLICATIONS AND OPERATION

The following list gives the frequency range and color code for each of the coils supplied with the Tunnel Dipper.

<u>COIL</u>	<u>FREQUENCY RANGE</u>
Red Band	3 mc to 7 mc
Purple Band	5 mc to 13 mc
Blue Band	12 mc to 32 mc
Green Band	30 mc to 90 mc
Yellow Band	80 mc to 160 mc
White Band	160 mc to 260 mc

FINDING RESONANT FREQUENCIES OF TUNED CIRCUITS

NOTE: When using the Tunnel Dipper as a frequency-measuring device, make certain that power is not applied to the tuned circuit being checked. If power is applied, incorrect frequency measurements and possible damage to the Tunnel Dipper could result.

Plug in the coil that will cover the frequencies to be encountered. Put the switch in the OSCillator position and adjust the SENSitivity control for a meter reading between 90 and 100.

Couple the Tunnel Dipper to the tuned circuit by holding the instrument so that its coil is touching the coil of the tuned circuit and the coil turns are parallel to each other, if possible. Vary the frequency of the Tunnel Dipper by turning the variable capacitor knob slowly until maximum needle dip is apparent. When the dip is obtained, decrease the coupling by moving the

Tunnel Dipper away from the tuned circuit coil until only a very slight dip of the needle occurs when you tune to the resonant frequency. Best accuracy is obtained with loose coupling. At dip, read the resonant frequency from the color dial matching the color of coil used.

When the Tunnel Dipper is closely coupled to a high "Q" tuned circuit there may be a peak reading when the dipper is tuned to 1/2 the resonant frequency of the tuned circuit. This condition does not interfere with the operation of the Tunnel Dipper.

Be careful not to place the instrument in a strong RF field, such as an operating transmitter tank circuit. The tunnel diode could be damaged by too much current in such a case.

WAVEMETER OPERATION

Plug in the coil that will cover the frequencies to be encountered. Put the switch in the DIODE position and adjust the SENSitivity control so that meter indicates about midscale. Since the meter circuit is nonlinear, greater sensitivity is achieved in the upper portion of the scale.

Place the coil of the Tunnel Dipper in the radio frequency field and vary the frequency of the Tunnel Dipper until a peak meter reading is found. For most accurate results, move the Tunnel Dipper away from strong signal sources to avoid pinning the meter. Read the frequency from the correct dial scale.

SIGNAL SOURCE OPERATION

The Tunnel Dipper can be used as signal source for receiver testing. Plug in the proper coil and set the Tunnel Dipper switch in the OSCillator position. Place the coil of the Tunnel Dipper near the antenna of the receiver to be tested. Adjust for the particular signal frequency needed.

EXTENDING THE FREQUENCY RANGE

The oscillator circuit of your Tunnel Dipper can be made to work up to approximately 350 mc by reducing the inductance of the plug-in coil. However, the tuning range of the instrument would be limited to only a small portion of the dial scale, since the minimum circuit capacity would become relatively large compared to the resonating capacity needed for the proper L-C ratio. Also, the inherent capacity of the tunnel diode has a larger effect on the frequency and this capacity varies somewhat from unit to unit.

IN CASE OF DIFFICULTY

1. Recheck the wiring. Trace each lead in colored pencil on the Pictorial as it is checked. It is frequently helpful to have a friend check your work. Someone who is not familiar with the unit may notice something consistently overlooked by the constructor.
2. It is interesting to note that about 90% of the kits that are returned for repair, do not function properly due to poor connections and soldering. Therefore, many troubles can be

Using coils with more inductance to lower the frequency limit below 3 mc will cause the oscillator to shift to a "relaxation" mode of operation. A relaxation mode of oscillation would cause indeterminate frequency readings and poor dipping characteristics, as well as a very distorted waveform.

BATTERY

For maximum battery life, always leave the switch in the OFF position when the Tunnel Dipper is not in use. The battery should be checked periodically and replaced if it becomes weak. Leaving the switch turned on until the battery is dead may also cause the battery to leak and damage the unit.

NOTE: For further study of the tunnel diode, the Tunnel Diode Manual is recommended. It can be obtained by sending \$1.00 to: Semi-Conductor Products Dept., Advertising and Sales Promotion, General Electric, Electronics Park, Syracuse 1, New York.

- eliminated by reheating all connections to make sure that they are soldered as described in the Proper Soldering Techniques section of this manual.
3. Check the transistors with a tester or by substitution of transistors of the same type.
4. Check the values of the component parts. Be sure that the proper part has been wired into the circuit, as shown in the

pictorial diagrams and as called out in the wiring instructions.

5. Check for bits of solder, wire ends or other foreign

matter which may be lodged in the wiring.

6. A review of the Circuit Description will prove helpful in indicating where to look for trouble.

TROUBLESHOOTING CHART

TYPE OF DIFFICULTY	POSSIBLE CAUSE
Meter deflects down scale	Battery reversed in holder.
Will not oscillate.	1. Tunnel diode installed backwards. 2. Coil socket terminals not making contact, or are shorted.
Frequency considerably higher than dial indicates.	Contactor spring may be bent so long pins no longer make contact.
Meter goes to full scale in either DIODE or OSC, and will not adjust.	1. Transistor Q2 is not in socket. 2. Try interchanging like transistors.
Meter drifts.	1. Some drift normal in first few minutes of operation, until transistors reach thermal equilibrium. 2. Battery nearly dead.

SERVICE INFORMATION

SERVICE

If, after applying the information contained in this manual and your best efforts, you are still unable to obtain proper performance, it is suggested that you take advantage of the technical facilities which the Heath Company makes available to its customers.

The Technical Consultation Department is maintained for your benefit. This service is available to you at no charge. Its primary purpose is to provide assistance for those who encounter difficulty in the construction, operation or maintenance of HEATHKIT equipment. It is not intended, and is not equipped to function as a general source of technical information involving kit modifications nor anything other than the normal and specified performance of HEATHKIT equipment.

Although the Technical Consultants are familiar with all details of this kit, the effectiveness of their advice will depend entirely upon the amount and the accuracy of the information furnished by you. In a sense, **YOU MUST QUALIFY** for GOOD technical advice by helping the consultants to help you. Please use this outline:

1. Before writing, fully investigate each of the hints and suggestions listed in this manual under In Case Of Difficulty. Possibly it will not be necessary to write.
2. When writing, clearly describe the nature of the trouble and

mention all associated equipment. Specifically report operating procedures, switch positions, connections to other units and anything else that might help to isolate the cause of trouble.

3. Report fully on the results obtained when testing the unit initially and when following the suggestions under In Case Of Difficulty. Be as specific as possible and include voltage readings if test equipment is available.
4. Identify the kit Model Number and Series Number, and date of purchase, if available. Also mention the date of the kit assembly manual. (Date at bottom of Page 1.)
5. Print or type your name and address, preferably in two places on the letter.

With the preceding information, the consultant will know exactly what kit you have, what you would like it to do for you and the difficulty you wish to correct. The date of purchase tells him whether or not engineering changes have been made since it was shipped to you. He will know what you have done in an effort to locate the cause of trouble and, thereby, avoid repetitious suggestions. In short, he will devote full time to the problem at hand, and through his familiarity with the kit, plus your accurate report he will be able to give you a complete and helpful answer. If replacement parts are required, they will be shipped to you subject to the terms of the Warranty.

The Factory Service Facilities are also available to you, in case you are not familiar enough with electronics to provide our consultants with sufficient information on which to base a diagnosis of your difficulty, or in the event that you prefer to have the difficulty corrected in this manner. You may return the completed instrument to the Heath Company for inspection and necessary repairs and adjustments. You will be charged a minimal fee, plus the price of any parts or material required. However, if the completed kit is returned within the Warranty period, parts charges will be governed by the terms of the Warranty. State the date of purchase, if possible.

Local Service by Authorized HEATHKIT Service Centers is also available in some areas and often will be your fastest, most efficient method of obtaining service. HEATHKIT Service Centers will honor the regular 90 day HEATHKIT Parts Warranty on all kits, whether purchased through a dealer or directly from the Heath Company; however, it will be necessary that you verify the purchase date of your kit.

Under the conditions specified in the Warranty, replacement parts are supplied without charge; however, if the Service Center assists you in locating a defective part (or parts) in your kit, or installs a replacement part for you, you may be charged for this service.

HEATHKIT equipment purchased locally and returned to Heath Company for service must be accompanied by your copy of the dated sales receipt from your authorized HEATHKIT dealer in order to be eligible for parts replacement under the terms of the Warranty.

THIS SERVICE POLICY APPLIES ONLY TO COMPLETED EQUIPMENT CONSTRUCTED IN ACCORDANCE WITH THE INSTRUCTIONS AS STATED IN THE MANUAL. Equipment that has been modified in design will not be accepted for repair. If there is evidence of acid core solder or paste fluxes, the equipment will be returned NOT repaired.

For information regarding modification of HEATHKIT equipment for special applications, it is suggested that you refer to any one or more of the many publications that are available on all phases of electronics. They can be obtained at or through your local library, as well as at most electronic equipment stores. Although the Heath Company sincerely welcomes all comments and suggestions, it would be impossible to design, test, evaluate and assume responsibility for proposed circuit changes for special purposes. Therefore, such modifications must be made at the discretion of the kit builder, using information available from sources other than the Heath Company.

REPLACEMENTS

Material supplied with HEATHKIT products has been carefully selected to meet design requirements and ordinarily will fulfill its function without difficulty. Occasionally improper instrument operation can be traced to a faulty component. Should inspection reveal the necessity for replacement, write to the Heath Company and supply all of the following information.

- A. Thoroughly identify the part in question by using the part number and description found in the Manual Parts List.
- B. Identify the kit Model Number and Series Number.
- C. Mention date of purchase.
- D. Describe the nature of defect or reason for requesting replacement.

The Heath Company will promptly supply the necessary replacement. PLEASE DO NOT RETURN THE ORIGINAL COMPONENT UNTIL SPECIFICALLY REQUESTED TO DO SO. Do not dismantle the component in question as this will void the guarantee. This replacement policy does not cover the free replacement of parts that may have been broken or damaged through carelessness on the part of the kit builder.

SHIPPING INSTRUCTIONS

In the event that your equipment must be returned for service these instructions should be carefully followed.

Be sure to return the complete kit including all of the plug-coils. Do not send the battery.

ATTACH A LETTER TO THE OUTSIDE OF THE CARTON BEARING YOUR NAME, COMPLETE ADDRESS, DATE OF PURCHASE AND A BRIEF DESCRIPTION OF THE DIFFICULTY ENCOUNTERED. Wrap the equipment in heavy paper, exercising care to prevent damage. Place the wrapped equipment in a stout carton of such size that at least three inches of shredded paper, excelsior, or other resilient packing material can be placed between all sides of the wrapped equipment and the carton. Close and seal the carton with gummed paper tape, or alternately, securely with stout cord. Clearly print the address on the carton as follows:

To: HEATH COMPANY
Benton Harbor, Michigan 49022

Include your name and return address on the outside of the carton. Preferably affix one or more "Fragile" or "Handle With Care" labels to the carton, or otherwise so mark with crayon of bright color. Ship by insured parcel post or prepaid express; note that a carrier cannot be held responsible for damage in transit if, in HIS OPINION, the article is inadequately packed for shipment.

WARRANTY

The Heath Company warrants that the parts supplied in its kits (except batteries) shall be free of defects in materials and workmanship under normal conditions of use and service. The obligation of Heath under this warranty is limited to replacing or repairing any such part upon verification that it is defective in this manner. This obligation is further limited to such defective parts for which Heath is notified of the defect within a period of ninety (90) days from the original date of shipment of the kit.

The obligation of Heath under this warranty does not include either the furnishing or the expense of any labor in connection with the installation of such repaired or replacement parts. The obligation of Heath with respect to transportation expenses is limited to the cost of shipping the repaired or replacement parts to the buyer, provided such repair or replacement comes within the terms of this warranty.

The foregoing warranty extends only to the original buyer and is expressly in lieu of all other warranties, expressed or implied. The foregoing warranty is further in lieu of all other obligations or liabilities on the part of Heath, and in no event shall the Heath Company be liable for any anticipated profits, consequential damages, loss of time or other losses incurred by the buyer in connection with the purchase, assembly or use of the kit product or components thereof.

The foregoing warranty shall be deemed completely void if acid core solder or paste flux or other corrosive solders or fluxes have been used in assembling or repairing the kit product. Heath will not replace or repair any parts of any kit products in which such corrosive solders or fluxes have been used.

This warranty applies only to Heath products sold and shipped to points within the continental United States and to APO and FPO shipments. Warranty replacement for Heath products sold or shipped outside the United States is on an f.o.b. factory basis. Contact the Heath authorized distributor in your country or write: Heath Company, International Division, Benton Harbor, Michigan, U.S.A.

HEATH COMPANY

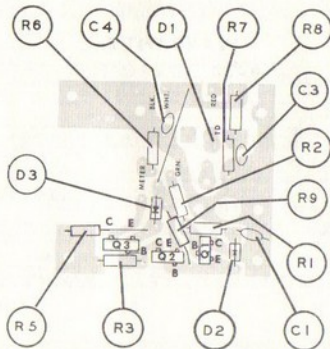

X-RAY VIEW
(RESISTORS)
(CAPACITORS)

REPLACEMENT PARTS PRICE LIST

PART No.	PRICE Each	DESCRIPTION
RESISTORS		
1-1	.10	47 Ω 1/2 watt
1-119	.10	560 Ω 1/2 watt
1-9	.10	1000 Ω 1/2 watt
1-19	.10	6800 Ω 1/2 watt
1-26	.10	100 K Ω 1/2 watt
CAPACITORS-CONTROL-SWITCH		
21-33	.10	3.3 μ f disc capacitor
21-94	.15	.05 μ f disc capacitor
26-86	4.00	2-section variable capacitor
10-90	.75	100 K Ω control
60-30	.40	Slide switch
COILS		
40-401	1.45	Red band (3 to 7 mc)
40-402	1.35	Purple band (5 to 13 mc)
40-403	1.35	Blue band (12 to 32 mc)
40-404	1.35	Green band (30 to 90 mc)
40-405	1.25	Yellow band (80 to 160 mc)
40-469	1.00	White band (150 to 260 mc)
HARDWARE		
250-49	.05	3-48 screw
250-156	.10	4-40 setscrew, allen head
250-213	.05	4-40 x 5/16" screw, pan head
250-4	.05	4-40 x 3/8" screw, round head

PART No.	PRICE Each	DESCRIPTION
Hardware (cont'd.)		
250-95	.05	5-40 x 3/4" screw
250-70	.05	6-32 x 3/16" screw, flat head
250-124	.05	6-32 x 3/16" screw, fillister head
250-89	.05	6-32 x 3/8" screw
250-43	.05	8-32 setscrew
252-1	.05	3-48 nut
252-15	.05	4-40 nut
252-40	.05	5-40 nut
252-3	.05	6-32 nut
252-22	.05	Speednut
252-39	.05	1/4-32 control nut
252-7	.05	3/8-32 control nut
253-1	.05	Fiber flat washer, thin
253-2	.05	Fiber shoulder washer
253-34	.05	Fiber flat washer, thick
253-10	.05	5/8" OD flat steel washer
253-39	.05	9/16" OD flat steel washer
254-7	.05	#3 lockwasher
254-9	.05	#4 lockwasher
254-1	.05	#6 lockwasher
254-14	.05	1/4" lockwasher
254-5	.05	3/8" lockwasher
255-1	.05	1/8" spacer
255-3	.05	3/8" spacer
255-11	.15	1" tapped spacer
258-5	.10	Contacting spring
258-31	.10	Battery spring

<u>PART</u>	<u>PRICE</u>	<u>DESCRIPTION</u>
<u>No.</u>	<u>Each</u>	

Hardware (cont'd.)

259-6	.05	Solder lug
260-11	.05	Catch clip
262-4	.10	Catch pin

SHEET METAL PARTS

90-203-1	.30	Cabinet top, inside (gray)
90-202	1.25	Cabinet top, outside (green)
90-197	2.20	Cabinet bottom
100-354	.45	Dial drum
200-327	.60	Chassis
203-281-2	.90	Front panel
204-445	.25	Battery bracket

MISCELLANEOUS

56-26	.30	Crystal diode
56-10	.85	Silicon diode (TIG247)
56-17	6.50	Tunnel diode, GE STD 633
347-7	.10/ft	4-conductor cable
85-67-1	.60	Circuit board
212-4	.15	Connecting strip
382-44	.50	Foam coil holder
390-120	.10	Battery placement label
390-122	.20	Dial drum label



















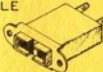
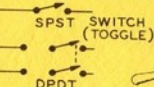
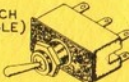



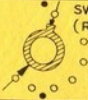

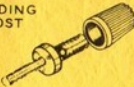
<u>PART</u>	<u>PRICE</u>	<u>DESCRIPTION</u>
<u>No.</u>	<u>Each</u>	

Miscellaneous (cont'd.)

407-87	8.10	Meter
417-50	1.50	TI363 transistor
417-28	.75	2N407 transistor
434-42	.10	Phono socket
434-70	.20	Transistor socket
446-32	.25	Dial window
455-26	.15	Bushing
462-139	.30	Large knob
462-175	.15	Small tapered knob
490-23	.10	Allen wrench
331-6	.10	Solder
595-618	2.00	Manual

The above prices apply only on purchases from the Heath Company where shipment is to a U.S.A. destination. Selling prices elsewhere in U.S.A. may be slightly higher to offset transportation and local taxes. Outside the U.S.A. parts and service are available from your local Heathkit source and will reflect additional transportation, taxes, duties and rates of exchange.

TYPICAL COMPONENT TYPES

 <p>POWER TRANSFORMER</p> 	 <p>PHONE JACK</p> 	 <p>METER</p> 
 <p>INDUCTOR (COIL)</p> 	 <p>RECEPTACLE</p> 	 <p>SPST SWITCH (TOGGLE) DPDT</p> 
 <p>PIEZOELECTRIC CRYSTAL</p> 	 <p>SPEAKER</p> 	 <p>SWITCH (ROTARY)</p> 
 <p>BINDING POST</p> 	 <p>MICROPHONE</p> 	 <p>FUSE</p> 
 <p>GENERAL ANTENNA</p>  <p>LOOP</p>	 <p>EARTH GROUND</p>  <p>CHASSIS GROUND</p>	<p>CONDUCTORS</p>  <p>NOT CONNECTED CONNECTED SHIELDED</p>

HEATH COMPANY

BENTON HARBOR, MICHIGAN

THE WORLD'S FINEST ELECTRONIC EQUIPMENT IN KIT FORM